

FLOLOGIC SYSTEM® 3.0

INSTALLATION AND SETUP INSTRUCTIONS (LEAVE WITH CUSTOMER)

Thank you and congratulations on your selection of the FloLogic System. By purchasing the FloLogic System you have taken a critical first step toward a proactive approach to water conservation and in preventing water damage due to burst, leaking pipes and failure of plumbing system components.

BEFORE YOU BEGIN - IMPORTANT CONSIDERATIONS

- Installation of the FloLogic System requires a basic knowledge of plumbing as well as specialized tools for cutting pipe and joining fittings.
- Depending on local building codes, a building permit may be required.
- If your home has an irrigation system or water softener installed on the main water line, consider installing the FloLogic System downstream of these systems.
- You will need a 120V electrical outlet within 20 feet of where the Valve will be installed.
- If the Control Panel is to be remotely located from the Valve, you may need to fish the control cable through wall and / or floor cavities between the Valve and the Control Panel.
- If you are not comfortable with any of these procedures, FloLogic suggests you hire an experienced professional plumber and / or electrician to complete the work.
- **DO NOT INSTALL THE SYSTEM ON SUPPLY LINES FOR FIRE SUPPRESSION SYSTEMS.**

UNPACK CARTON AND CHECK CONTENTS

After opening the box containing the FloLogic System ("System"), make a note of any damage to the outer shipping box. If damages were noted to the outer shipping carton, inspect the inner cartons to determine whether the damage affected the various System components. If shipping damage has occurred, report the damages to the shipping company and notify FloLogic at info@floglogic.com or call us, toll-free at 1-877-FLOLOGIC (356-5644) between 9 a.m. and 5 p.m., Eastern.

CONTENTS CHECKLIST

Control Panel

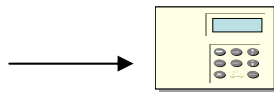

Power Supply / AC Converter

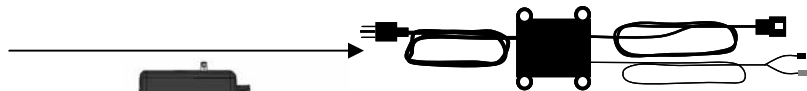

Valve Assembly with Actuator

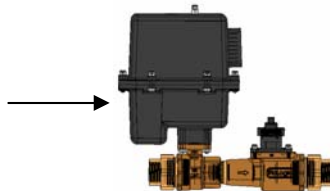

Communication Cable

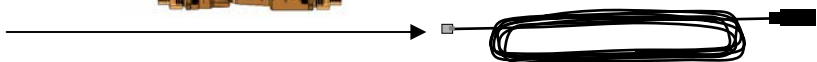

Sealed Lead-Acid Battery

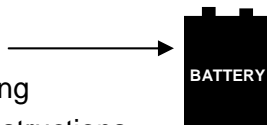

Documentation Pack Including
Installation and Setup Instructions
Directions for Use
Warranty Registration
Keypad Mounting Screws and Drywall Anchors

IMPORTANT NOTE: In order to bring the battery to a fully charged state (13.8V), prior to the time of System start-up, connect the battery to the power supply and plug the power supply into to any convenient electrical outlet before starting installation of the valve.

FloLogic System 3.0 Specifications

General:	One inch (1”), lead free bronze valve Full port, stainless steel ball PTFE (Teflon®) seals on ball valve EPDM gasket seals on union fittings Equipped with 1” FNP (FIP) union fittings (both ends) Integrated manual override
Valve assembly:	Length - 10”, Height - 10.75” , Depth – 5.25” Weight – 10.25 lbs
Flow sensitivity:	User adjustable, 0.5–32 ounces per minute
Power:	120 VAC / 60 Hz, Current draw – 300 mA (0.3 amps)
Battery Back-up:	12 Volt DC, Sealed Lead Acid, 4, 4.5, or 5 Amp Hour Standby time: 3 – 7 days (on battery alone) Continues to monitor flow and closes valve, if needed due to leak
Pressure Limits:	Maximum: 150 psi at 73.4° F (23° C) Working: 100 psi at 73.4° F (23° C)
Environmental:	Water Temp: Min 34° F (0° C) - Max 140° F (60° C) Ambient Air: Min 35° F (0° C) - Max 120° F (50° C)
Compatible Piping:	Copper Galvanized Polybutylene PVC / CPVC PEX All others with proper fittings
Control Panel:	UL listed, ABS plastic with backlit alpha-numeric LCD Soft touch silicone keypad
Regulatory:	Listed with UL, ULC, IAPMO, UPC, NSF 61 compliant
Warranty:	Five years on valve One year on electronics

Headloss vs Rate of Flow

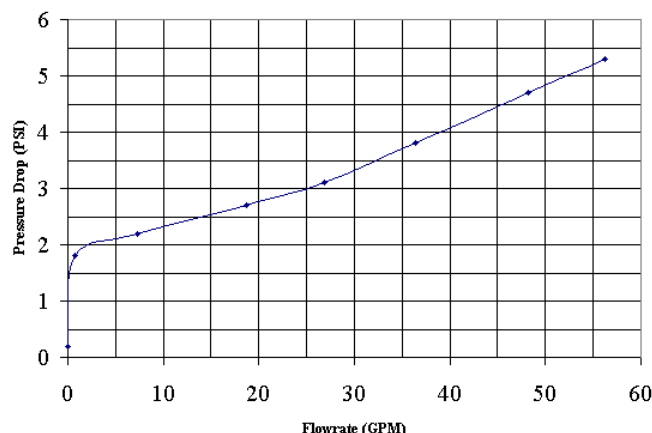

INSTALLATION GUIDE CONTENTS

Installation Times are Estimates Based on Field Observations

PLANNING AND PREPARATION (15 - 45 minutes)

- Step 1 - Determine Valve Location
- Step 2 - Locate Existing or Install New Electrical Outlet
- Step 3 - Shut-Off House Water and Drain Pipes

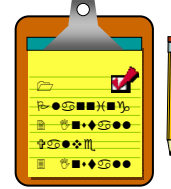

VALVE INSTALLATION (45 – 90 minutes)

- Step 4 - Measure, Mark, and Cut Pipe
- Step 5 - Install Fittings onto Water Line
- Step 6 - Install Valve onto Water Line

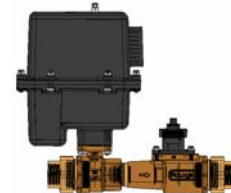

CONNECTING THE CONTROL PANEL (15 – 90 minutes)

- Step 7 - Determine Control Panel Location
- Step 8 - Run Communication Cable
- Step 9 - Install Control Panel

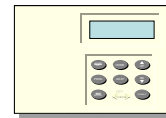

CONNECT BATTERY AND POWER SUPPLY (5 minutes)

- Step 10 - Connect the Battery to the Power Supply
- Step 11 - Plug in Power Supply to 120V AC Outlet
- Step 12 - Connect Power Supply to Valve

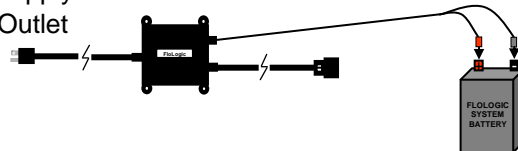

OPERATIONAL TEST (10 minutes)

- Step 13 – Confirm System is in HOME Mode
- Step 14 – Check for Background Water Flow
- Step 15 – Confirm Flow Detection
- Step 16 – Confirm Control Panel Water Shutoff
- Step 17 – Confirm Automatic Shutoff



REFERENCE MATERIAL

Installation Troubleshooting	15
External System Interconnect Options	16
Wiring Outputs to External Systems	17
Irrigation Override	18
Water Softener Override	19
Watertight Connector Manipulation	19
Product Warranty	20
Basic System Layout	Back Cover

PLANNING AND PREPARATION

STEP 1 – DETERMINE OPTIMAL VALVE LOCATION

The Valve assembly should be located on the main water line after the line enters the structure but prior to the breakout of any distribution lines serving your plumbing appliances. **Like any water supply component, the Valve should be located in an area that is not subject to freezing conditions.** Unless your home is built on a concrete slab, this will typically be in a basement or crawl space. If your home is built on a concrete slab, or you prefer to install the Valve assembly outside the footprint of your home, you will need to provide an enclosure to protect the Valve from water and freezing conditions. **If below grade, a watertight (NEMA 6) enclosure is required.** The System is rated to operate continuously with water pressure up to 100 PSI. If your water pressure exceeds 100 PSI, install a pressure reducing valve prior to the FloLogic System.

Whether you choose to place the Valve inside or outside the footprint of your home, a 120V AC electrical outlet will need to be available. If you need to deploy the Valve further than 20 feet from an available AC source, you can either install a new electrical outlet or purchase a power extension cable from FloLogic .

The Valve assembly is 10 inches long, 10¾ inches tall, and 5 ¼ inches deep. When selecting the point on the water main to install the valve, consideration must be given to these dimensional specifications as well as for supporting the Valve to prevent any undue strain on the piping interconnections. The Valve assembly weighs approximately 10 pounds and should be secured by clamping or strapping to a stud, a wall, or a joist.

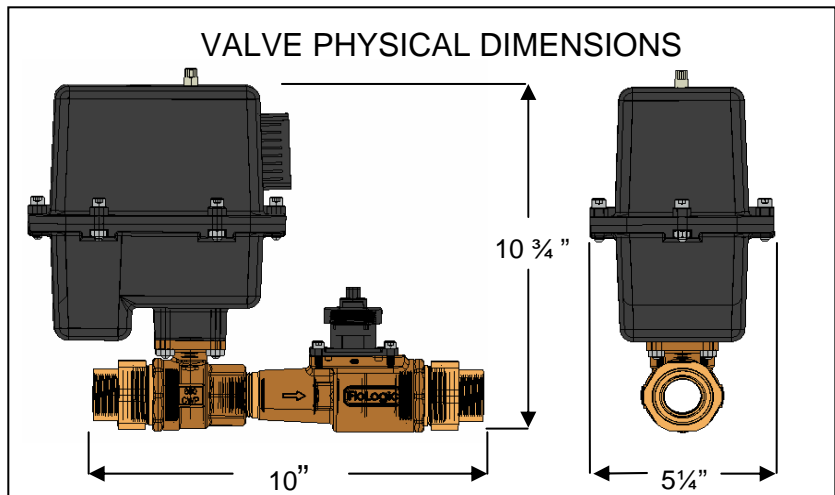

The Valve can be installed on a horizontal or vertical pipe run. In a vertical pipe, there are no limitations as to orientation. On a horizontal pipe the Valve can be installed with the black actuator housing either directly above or below the pipe. **Do not install the Valve with the actuator housing on its side (parallel to the pipe). Doing so may reduce flow sensitivity and shorten the life of the flow sensor (See below).**

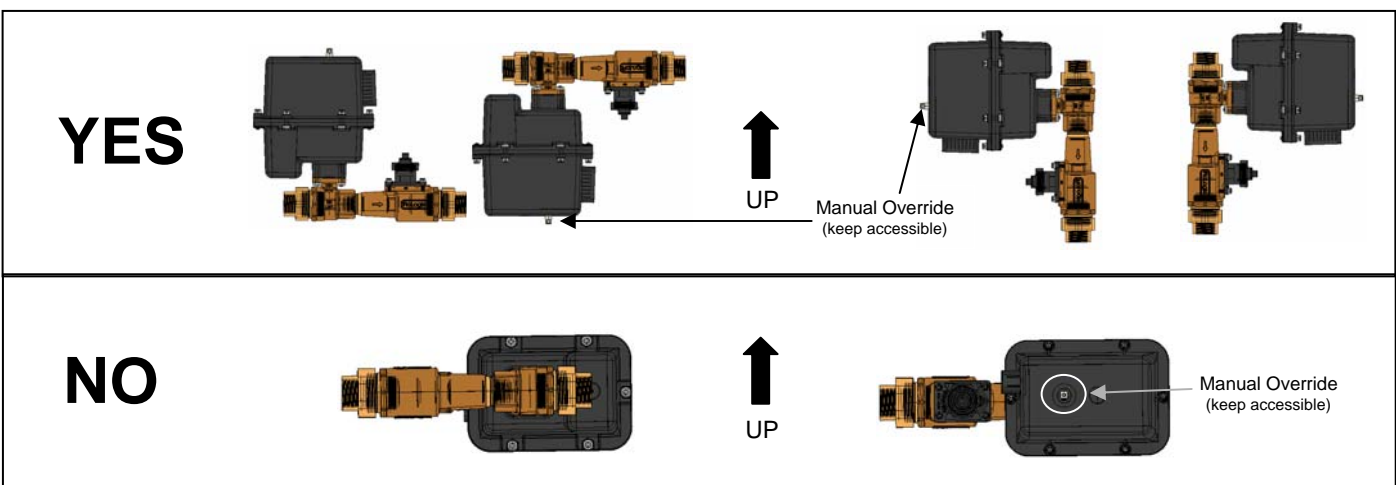

IMPORTANT NOTE: Manual Override Access and Planning for Irrigation and Water Softeners

The FloLogic System is equipped with an override that will allow you to manually open or close the valve with a 5/16" (8 mm) wrench in the event of a complete loss of power. When planning for the location of the Valve, provide sufficient clearance to accommodate access to this override. Every attempt should be made to locate the FloLogic valve AFTER distribution lines are tapped off for automatic irrigation systems and after automatic water softeners. If this is not feasible, additional wiring interfaces may be required to manage the water used by these appliances (see Reference Material beginning on page 16).

PLANNING AND PREPARATION (continued)

STEP 2 – LOCATE EXISTING OR INSTALL NEW ELECTRICAL OUTLET

If you do not already have an electrical outlet within 20 feet of the Valve location, you will need to install one yourself or have one professionally installed by an electrician. Alternatively, if an AC source is available, but further than 20 feet from the Valve location, watertight Power Supply extension cables are available for purchase from FloLogic. The use of a household extension cord is not recommended.

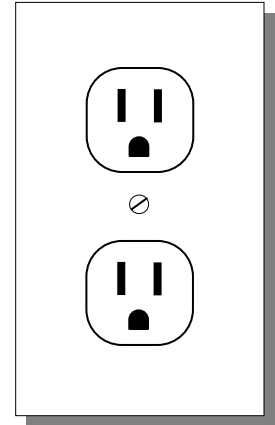

The FloLogic System consumes very little power and as such, does not require any special electrical considerations. The Power Supply is equipped with a grounded, three-prong plug attached to a 6 foot cord. The Power Supply case has molded “ears” designed to be used to secure it to a wall or floor joist.

From the Power Supply, there is a 15 foot cable that connects to the Valve. While the interconnect cable and connector between the Power Supply and the Valve are water resistant, the Power Supply must be protected from weather and kept dry at all times. Contact info@flologic.com or call (877) Flo-Logic to order water resistant power cable extensions if needed.

STEP 3 - SHUT-OFF HOUSE WATER AND DRAIN PIPES

Before beginning the installation of the Valve, the water to the home should be shut-off at the water meter. If you are on a well, disable the well pump by switching off the appropriate electrical circuit breaker. Open a cold water faucet at the lowest elevation point in the home and let the water run until it stops. In some homes, the lowest elevation faucet will be a hose bib on the outside of the home. If you have a multi-story home, open a couple cold water taps on the upper-most floor to break the plumbing system vacuum and improve drainage. Depending on the design of your home's plumbing, the draining of the water line may take as long as 15 minutes.



You have now completed the planning and preparation work and are ready to install the Valve and Flow Sensor assembly.

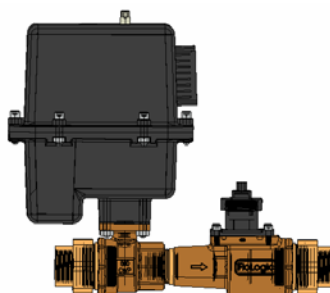

FloLogic System Valve and Flow Sensor Assembly

VALVE INSTALLATION

STEP 4 – MEASURE, MARK, AND CUT PIPE

Depending on your plumbing system, you will need one or more pipe fittings to transition from your water pipe to the 1" female (NPT) threaded connection on the FloLogic Valve. **A check valve is recommended to be installed on the inbound water line prior to the FloLogic Valve.** The check valve will reduce or eliminate false flow readings as the pressure in the water main rises or falls throughout the day. If installing a new check valve, make sure a thermal expansion tank is installed in the home. Assemble and / or tighten the various fittings required to transition from the main water line to the FloLogic Valve. Use Teflon tape to wrap the 1" male threads of the two assembled transition fittings (one for each end) and securely tighten into the union tailpiece on each end of the FloLogic Valve. You are now ready to measure and mark the pipe before cutting out a section to accommodate the Valve assembly.

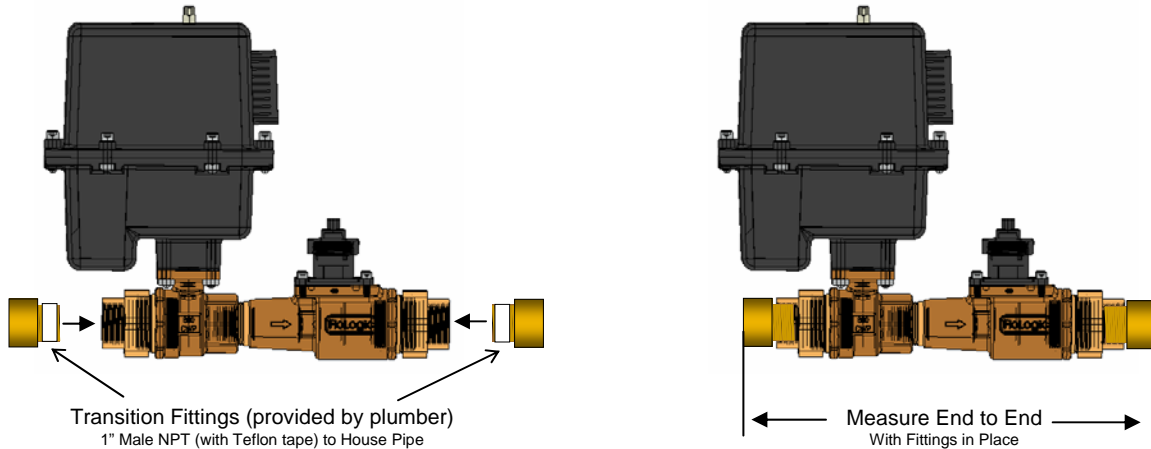

Carefully measure the overall length of the assembled Valve and fittings. Take this measurement and mark it on the water pipe where you intend to locate the FloLogic Valve. Next, determine how far the pipe will insert into each of the transition fittings when assembled after cutting. Typically, for copper and CPVC, this is equal to the diameter of the pipe (e.g. a $\frac{3}{4}$ " pipe will insert $\frac{3}{4}$ " and a $\frac{1}{2}$ " pipe will insert $\frac{1}{2}$ "). Reduce the width of the overall measurement by these insertion lengths. In the $\frac{3}{4}$ " pipe example cited above, the overall measurement would be reduced by $1\frac{1}{2}$ " ($2 \times \frac{3}{4}$ " = $1\frac{1}{2}$ "). Mark the reduced overall length on the pipe and prepare to cut the pipe.

NOTE: Prior to cutting into the pipe, it is recommended that you position a large bucket under the pipe to catch any water that remains in the line even after draining the house lines.

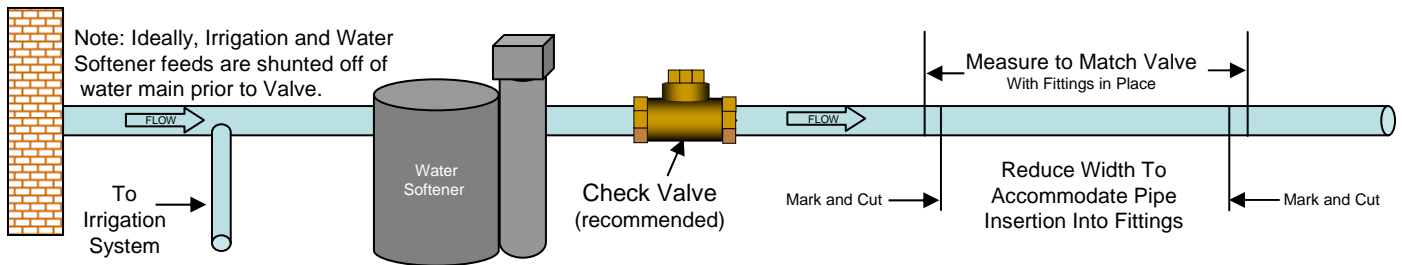

Using the appropriate tools, cut the pipe in the places marked. Be careful to make a clean, square cut to ensure minimal clean-up and prep work before installing the fittings. Additional pipe supports may be required if the cut pipe sags excessively.

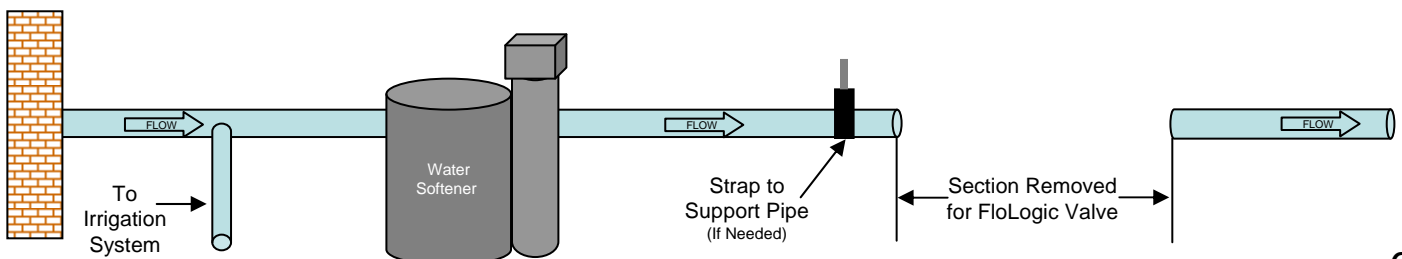

VALVE INSTALLATION (continued)

STEP 5 – INSTALL FITTINGS ONTO WATER LINE

To facilitate a simple installation, both ends of the Valve are equipped with union fittings. The transition fittings you installed in Step 5 will be threaded into the union tailpieces. Remove the unions by loosening the large brass nut at each end of the Valve. There is a rubber seal inside each of the unions that provides a face seal for the connection. Be certain to keep the seals with the unions for later re-installation. Do not worry about keeping track of which union comes from which end of the Valve as they are interchangeable.

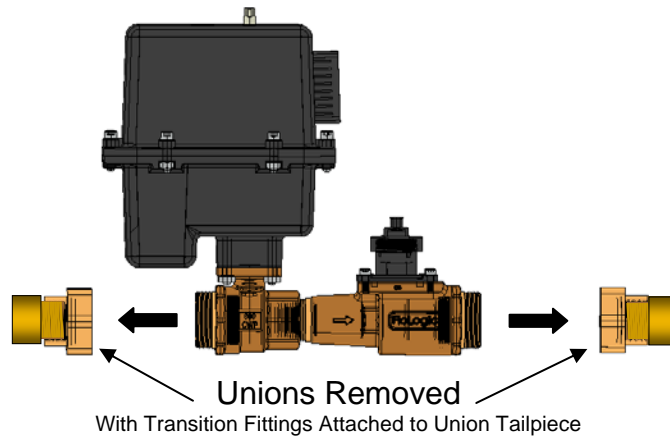

Dry fit the transition fittings onto the water line you cut in Step 5. If there is sufficient clearance for the union nut to slide over the transition fittings and onto the pipe, slip the union nut down the pipe and out of the area where you will be attaching the fittings to the pipe.

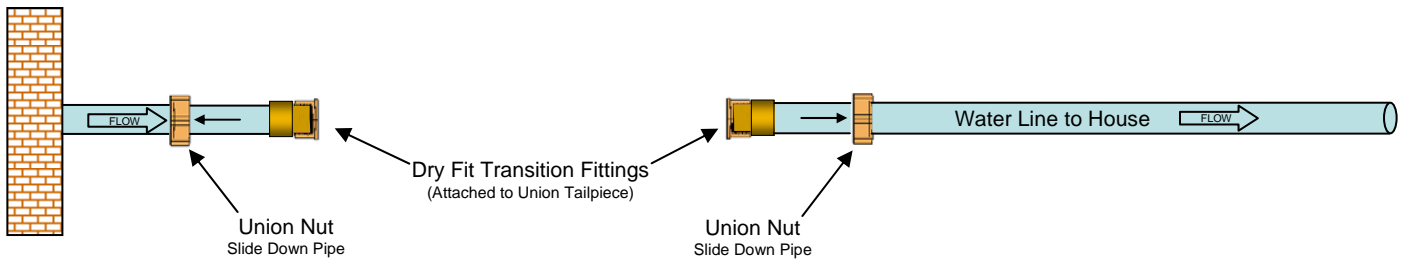

Confirm that the Valve will easily slide into the gap between the union tailpieces. Make any adjustments necessary by either moving the pipe or repeating Step 5 if moving the pipe does not work. You are now ready to secure the fittings to the pipe.

CAUTION: Before installing fittings onto pipe, make sure the union nut is in place as described and depicted above. If not, you will have to remove (unscrew) the union tailpiece, insert the union nut, apply fresh Teflon tape, and retighten the connection between the tailpiece and your pipe fittings.

Follow the fitting manufacturer's instructions for this process. If you are soldering a copper fitting on the pipe, it is recommended that you remove the union tailpiece from the fitting assembly prior to soldering. This can be re-installed after the solder joint has cooled. If you do remove the union tailpiece, remember to use fresh Teflon tape when re-installing the tailpiece to the fittings.

CAUTION: DO NOT USE PLUMBER'S PUTTY OR PIPE JOINT COMPOUND AS THIS CAN INTERFERE WITH, OR FOUL THE FLOW SENSOR.

You are now ready to install the Valve into the water line.

VALVE INSTALLATION (continued)

STEP 6 – INSTALL VALVE ONTO WATER LINE

Orient the Valve so the direction of flow indicated by the arrow cast into the valve body matches the direction of water flow through the pipe. The large, black actuator housing will be on the inlet side of the Valve and the flow sensor assembly will be on the outlet side of the Valve.

Position the Valve between the sections of cut pipe. Make sure the rubber gaskets are in place and hand tighten the large brass union nut onto each end of the Valve.

NOTE: Do not use Teflon tape, plumber's putty, or pipe joint compound on the threads for the union nut as the sealing surface is the face of the rubber gasket.

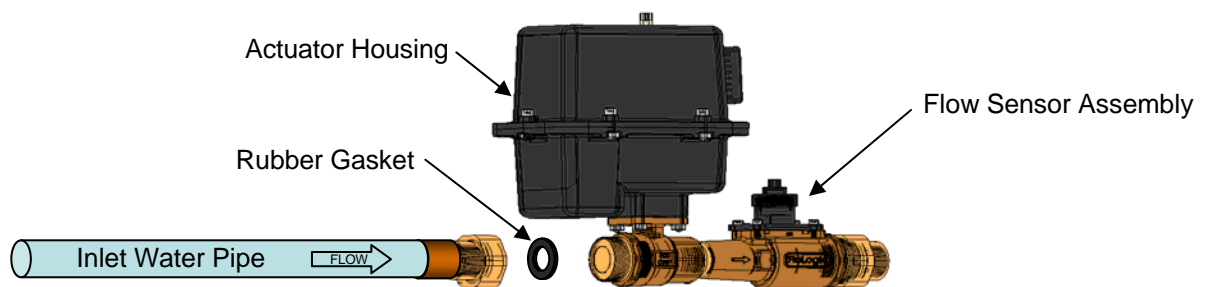

After positioning the Valve in an orientation that allows for easy access to the top of the actuator housing, tighten the large brass union nuts with an adjustable wrench or pipe wrench.

You may now slowly turn the water back on at the meter or by restarting your well pump. After restoring the water service, open all of the cold-water taps (including hose bibs) and flush toilets in the house to purge any air that was trapped in the plumbing system. Depending on your plumbing system, this may take several minutes. Close the cold water taps (and hose bibs if used) once you note a smooth flow of water with no air entrapment.

**You have now completed all of the plumbing work
and are ready to install the Control Panel.**

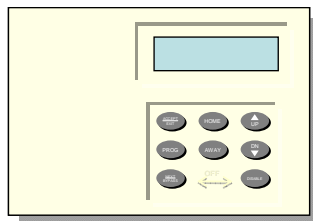

FloLogic System Control Panel

CONNECTING THE CONTROL PANEL

STEP 7 – DETERMINE CONTROL PANEL LOCATION

All user messages and inputs to the FloLogic System are accomplished through the Control Panel. Ideally, the Control Panel should be mounted slightly below eye level on a wall that is convenient to access when you are entering or exiting your home or business. If that is not possible for aesthetic or mechanical reasons, the Control Panel can be mounted anywhere deemed convenient.

The Control Panel is connected to the Valve via the supplied, 50 foot Communication Cable. After selecting the location for the Control Panel, carefully measure both the vertical and horizontal distances (rise and run) between the Valve and the desired Control Panel location. If 50 feet of cable is not sufficient for your application, a watertight Communication Cable extension may be purchased from FloLogic. If a watertight connection is not required you may purchase a standard phone cable at a local electronics retailer. Be certain to purchase a phone extension cord designed to handle two or more phone lines and is equipped with a plug (RJ-11 type) on one end and a jack on the other end. The supplied 50 foot Communication Cable will plug into the jack of the purchased cable and the plug from the new cable will then plug into the FloLogic Control Panel.

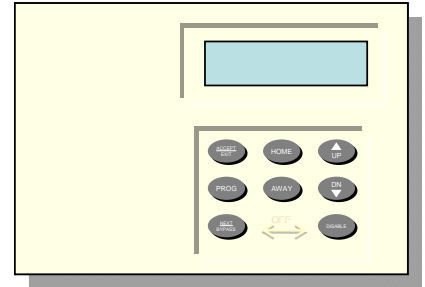

If you are connecting the FloLogic System to your home security system, you should locate the Control Panel near your security system controller. Typically the security controller is located in a closet in a lockable metal enclosure. The FloLogic System can accept commands from your security system such as switching from Home to Away when you are arming your security system. In addition, when properly configured, the FloLogic System will alert your security system when it detects a leak condition and shuts off the water. See the section on External System Integration on pages 16, 17, and 18 of this installation guide for more information and wiring diagrams for the various options.

STEP 8 – RUN COMMUNICATION CABLE

Plug in the larger, black connectorized end of the communication cable to the matched connector on the Valve. Push the Communication Cable connector firmly into the wiring harness connector on the Valve until you hear an audible “click” indicating a secure connection has been made. Run the smaller, phone-type connectorized end of the cable to the location where you plan to install the Control Panel. If the Control Panel is to be installed in a high visibility area of your home or business and you wish to hide the wiring behind the wall, this may require you to pull the wire through one or more wall cavities and up through sub-flooring. At the Control Panel installation site, be certain to leave at least 6 inches of cable slack to facilitate the Control Panel installation.

NOTE: No electrical box is required. The wire should exit the wall behind the planned location for the Control Panel. The Control Panel will cover the hole when it is installed in Step 9.

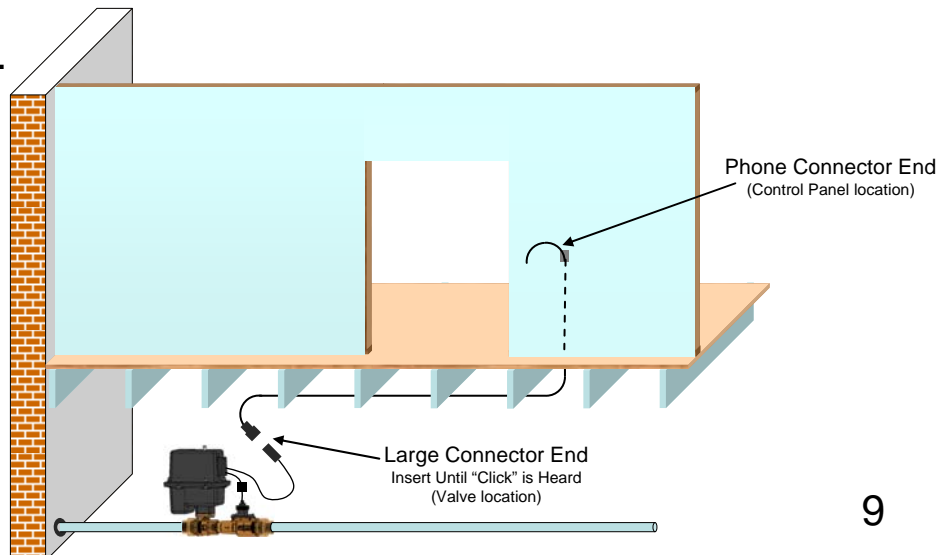

CONNECTING THE CONTROL PANEL (continued)

STEP 9 – INSTALL CONTROL PANEL

Open the Control Panel by depressing the tab on the top of the molded plastic housing.

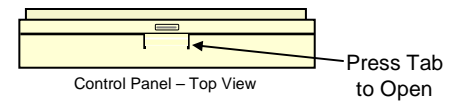

Separate Front and Rear Housings

With the Control Panel open, separate the back of the Control Panel from the front by gently bending one of the hinge “ears” out while pulling the front and back housings apart. Set aside the front housing using care to protect the circuit board and display from any liquid, dust, or construction debris.

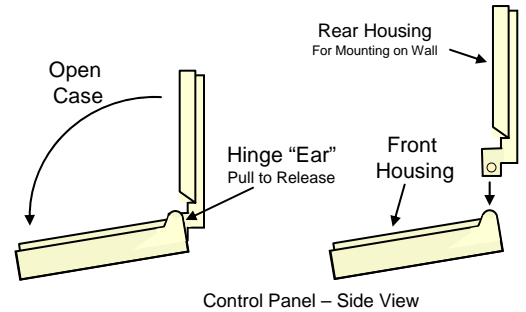

Attach Rear Housing to Wall

OPTION 1 - Hiding the Wiring Behind Wall

Push the connectorized wire through the rear entry cable access port molded into the rear housing. Slide the rear housing down the cable until it comes in contact with the wall. With a pencil and a level, mark the wall where the mounting holes pass through the housing. Using either the supplied fasteners or your own, attach the housing to the wall.

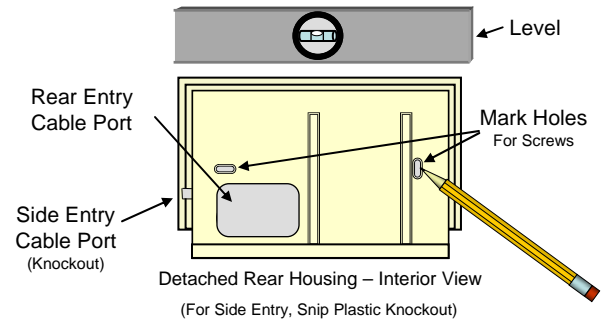

OPTION 2 – Surface Mount Wiring

Using a pair of wire snips or needle nosed pliers, remove the plastic knockout from the lower left side of the rear housing. With a pencil and a level, mark the wall where the mounting holes pass through the housing. Using either the supplied fasteners or your own, attach the housing to the wall.

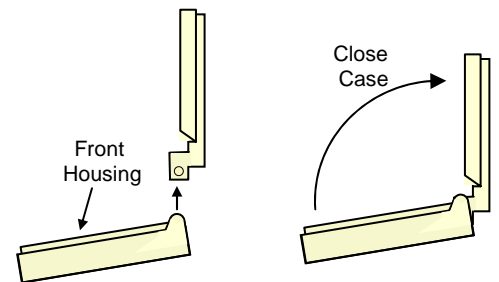

Re-Attach Control Panel to Rear Housing

Reverse the process you used to remove the front housing by inserting one of the hinge “ears” into its corresponding slot on the rear housing. Gently pulling the other hinge “ear” slide the second hinge into place. Confirm proper engagement of the hinge by closing and then re-opening the Control Panel.

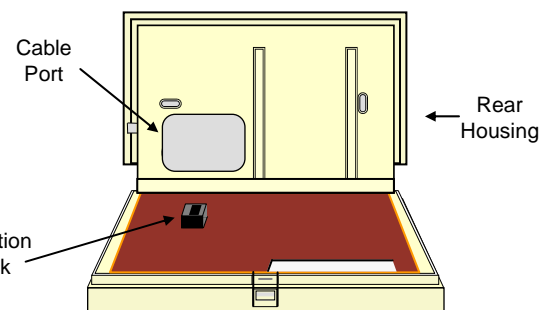

Plug-in Communication Cable to Control Panel

Plug in the telephone-style connector into the jack on the Control Panel board. Carefully close the Control Panel to make sure the cable does not bind.

You have now completed the installation of the Control Panel and are ready to install the System Battery and Power Supply.

CONNECT BATTERY AND POWER SUPPLY

(NOTE: ORDER OF CONNECTION IS IMPORTANT)

STEP 10 – Connect the Battery to the Power Supply

Prior to plugging the Power Supply into the 120V AC outlet connect the Battery to the Power Supply by sliding the quick disconnect terminals onto the Battery. Use care to match the insulated red quick disconnect to the red (+) battery terminal and the insulated black quick disconnect to the black (-) battery terminal.

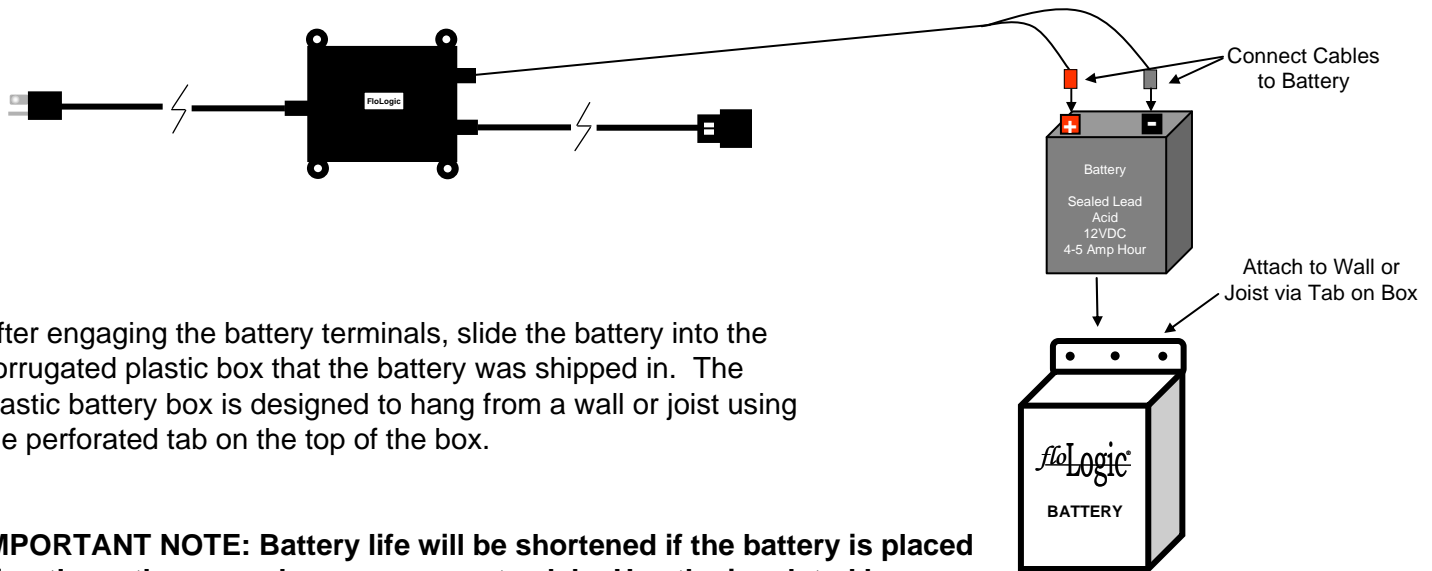

After engaging the battery terminals, slide the battery into the corrugated plastic box that the battery was shipped in. The plastic battery box is designed to hang from a wall or joist using the perforated tab on the top of the box.

IMPORTANT NOTE: Battery life will be shortened if the battery is placed directly on the ground or on a concrete slab. Use the insulated box provided to ensure maximum battery life.

STEP 11 – Plug in Power Supply to 120V AC Outlet

After connecting the Battery to the Power Supply, plug in the grounded power cord to the previously located 120V AC electrical outlet.

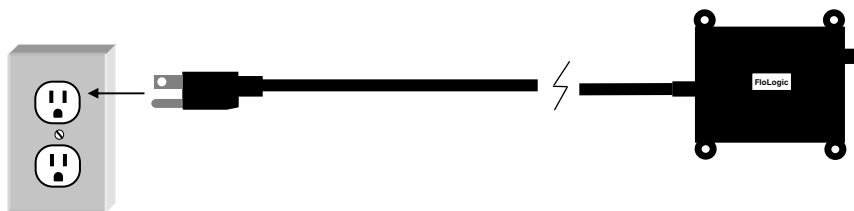

You are now ready to connect the Power Supply to the wiring harness on the Valve.

CONNECT BATTERY AND POWER SUPPLY (continued)

STEP 12 – Connect Power Supply to Valve

Insert the remaining connector on the Valve into the connector on the Power Supply until you hear an audible “click” confirming a secure connection has been made. NOTE: See page 19 for more detailed instructions on the use of the connectors.

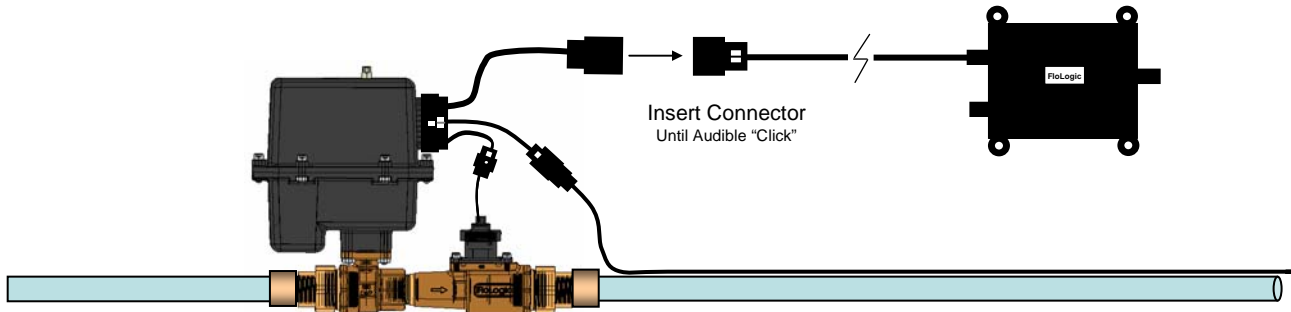

The Valve will now automatically begin a start-up routine to confirm all System components are working properly. During this start-up the display will progress through four (4) screens as follows. The numbers following C.VER and V.VER are software version codes and will vary depending on your System ship date.

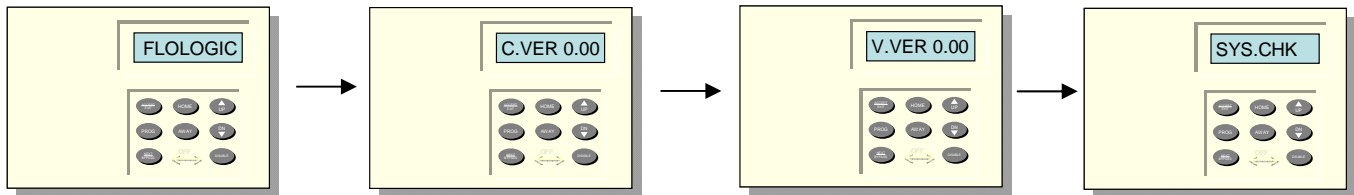

Once the start-up is completed, the display will read “HOME” indicating the System is ready for use.

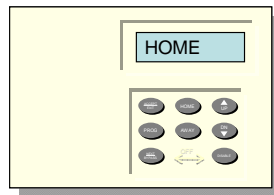

NOTE: If the Control Panel reads SYSDWN-CHGBATT this likely occurred because either the Power Supply was plugged into the outlet and the System attempted to start-up before the battery was connected or the battery requires additional charging. Once the battery is charged, simply hold down the DOWN ARROW until the beeping stops (approximately 4 seconds), release it and the System will re-boot and the message will clear.

IMPORTANT NOTE: Make sure that any residual air is purged from your home plumbing system by fully opening all cold-water faucets for at least two minutes and flushing all toilets. Trapped air will reduce the effectiveness of the flow sensor and prevent the proper performance of the System.

You have now completed the physical installation and are ready to test the operation of the System.

OPERATIONAL TEST

**THIS TEST SHOULD BE CONDUCTED SEMI-ANNUALLY
TO CONFIRM SYSTEM FUNCTIONALITY**

STEP 13 – CONFIRM SYSTEM IS IN HOME MODE

Prior to starting the operational test, please confirm the FloLogic System is in the Home mode. If the display reads “AWAY” or anything other than “HOME”, press the HOME key to place the System into the Home mode.

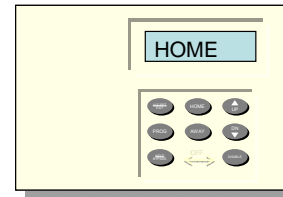

Control Panel is in Home mode

STEP 14 – CHECK FOR BACKGROUND WATER FLOW

After you have purged all of the residual air out of your pipes, all taps are securely closed and no toilets are running in the house, look at the right corner of the display on the Control Panel for an indication of water flow. When the FloLogic System detects flowing water a rotating pinwheel is displayed. Your home may have an expansion tank that was installed to prevent pressure build up due to thermal expansion from the water heater. If so, it will take additional time for the rotating pinwheel to stop after the water has been shut off as the expansion tank refills. This is normal and should not cause alarm.

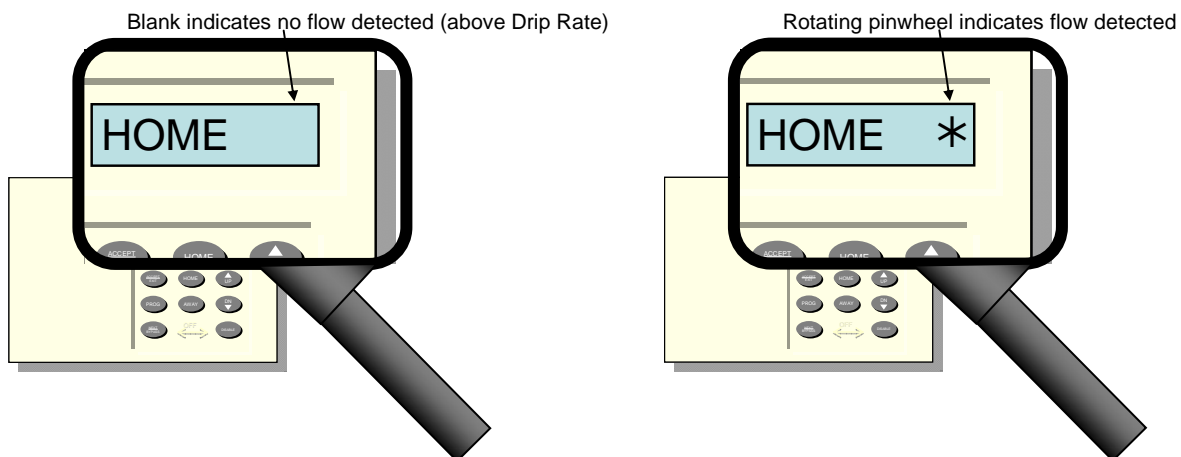

NOTE: If you believe you have no water running in the building and the pinwheel continues to be illuminated even after you have purged all of the residual air, you will need to check the amount of flow the system detects by using the Programming Menu. Instructions for using the Programming Menu can be found in the *Directions for Use* booklet beginning on page 18.

STEP 15 – CONFIRM FLOW DETECTION

Once the display indicates no flow is detected, turn on a cold water tap to confirm that the pinwheel illuminates. It may take a few seconds for the pinwheel to illuminate after you turn on the water.



Turn on cold water tap



Wait five to ten seconds

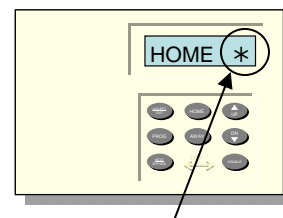

Look for flow indication

OPERATIONAL TEST (Continued)

***THIS TEST SHOULD BE CONDUCTED SEMI-ANNUALLY
TO CONFIRM SYSTEM FUNCTIONALITY***

STEP 16 – CONFIRM CONTROL PANEL SHUTOFF

While water continues to run from the open tap, press and hold the DISABLE key and then press the NEXT / BYPASS key on the Control Panel. The valve will close, the display will read “WATER.OFF”, and the water will stop flowing from the still-open tap. NOTE: In a multistory home or a home equipped with thermal expansion tanks, the flow may continue for several minutes.

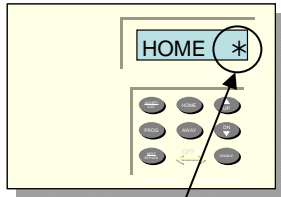

System is in Home mode,
Look for flow indication



Water continues to run

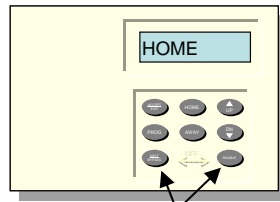

Press and hold Disable key,
then press Next / Bypass

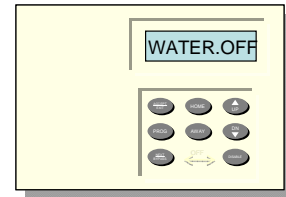

Control Panel reads WATER.OFF



Water is shutoff by FloLogic valve

NOTE: If the display reads “BYPASS”, you have pressed the NEXT / BYPASS key before you pressed the DISABLE key. If this happens press the Home key and repeat the keystrokes described above until “WATER.OFF” is displayed.

To restore water service, press the HOME key on the Control Panel.

STEP 17 – CONFIRM AUTOMATIC SHUTOFF

With the water running, place the System into the Away mode by pressing the AWAY key on the Control Panel. The Valve will cycle, perform a self-check, and update the display to read “AWAY”. Unless a different timer value has been set by the user, after 30 seconds of water flow, the Valve will rotate 90° to turn off the water, an audible alarm will be sounded at the Control Panel, and the display will read “LEAK”.

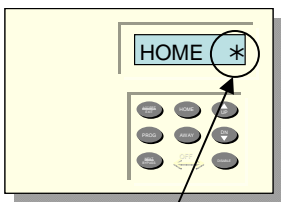

System is in Home mode,
Look for flow indication



Water continues to run

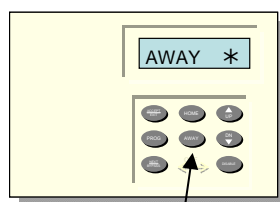

Press the AWAY key



Wait approximately 30 seconds

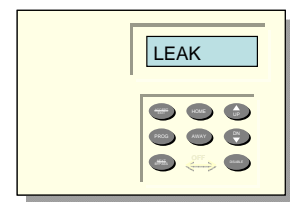

Control Panel displays LEAK
and sounds audible alarm



Water is shutoff by FloLogic valve

To silence the audible alarm, press the DISABLE key. To restore water service press the HOME key.

**CONGRATULATIONS, YOU HAVE NOW COMPLETED
THE INSTALLATION OF YOUR FLOLOGIC SYSTEM**

INSTALLATION TROUBLESHOOTING

For Toll Free Phone Support Call 1 (877) Flo-Logic (356-5644)

ERROR MESSAGES AND RESOLUTIONS

AC LOST	AC power not detected, System operating solely on battery power. Alarm output is delayed one hour to prevent alarm cycling during intermittent power outages.	Check to make sure Power Supply is plugged in and there is 120 VAC power at the outlet. Error message will automatically clear when AC power is restored.
COMM ERR	Communication between Valve and Control Panel inoperative. When 30 seconds passes with no handshake between the Valve and Control Panel, this message is displayed.	Check cable between Valve and Control Panel. Make sure there is no damage to the cable. Disconnect battery and unplug power supply, wait 15 seconds and reconnect both. System will reboot (valve cycles) and message will clear.
SYS DOWN	Valve inoperable due to discharged battery. Without battery, Valve is inoperable. Battery must be present at all times.	Check battery connections. Observe (+ / -) polarity. Press and hold DN on control panel until beeping stops. Release button. Valve will cycle after 8 seconds and System will reset.
VAL FAIL	Valve unable to detect open vs. closed position. Due to misaligned position sensor or override shaft in depressed position resulting in failure to read position.	Unplug Power Supply and disconnect battery. Wait 15 seconds then reconnect battery. Observe (+ / -) polarity. Plug in Power Supply. Valve will reboot and message will clear.
CHG BATT	Dead battery, battery recovering from discharge or battery plugged in after Power Supply plugged into outlet.	Check / Replace battery. Press and hold DN on Control Panel until beeping stops. Valve will cycle (after 8 seconds) and System will reset.

NOTE: In the event that none of the suggested resolutions above are effective in clearing an error condition, the entire System may be powered down and re-started. Known as a hard-reboot, this is accomplished by unplugging the Power Supply and removing one of the two Battery terminals. Wait approximately 15 seconds and reverse the process, connecting the Battery first and then plugging in the Power Supply. The Valve should re-start and any error messages cleared.

AIR ENTRAPMENT

For proper operation of the System, residual air must be purged from the plumbing lines.

Air will have entered the plumbing system when it was drained during the installation process. To purge this air, open each hot and cold water tap in your home until the water flows without sputtering and coughing. Flush all toilets and run the hot and cold water in your bath / shower to complete this process. Finally, start your clothes washer and let it fill the tub for a couple of minutes. This should eliminate any entrapped air.

See the *Directions for Use* enclosed in the shipping box for complete instructions on both System operation and programming for your specific requirements. Don't forget to mail in the enclosed warranty card or register your purchase at www.flologic.com by clicking on Product Registration. Keep a record of your purchase in the event of any warranty needs.

EXTERNAL SYSTEM INTERCONNECT OPTIONS

Located on Control Panel Circuit Board

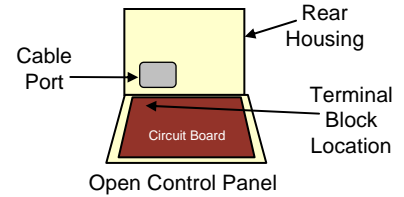
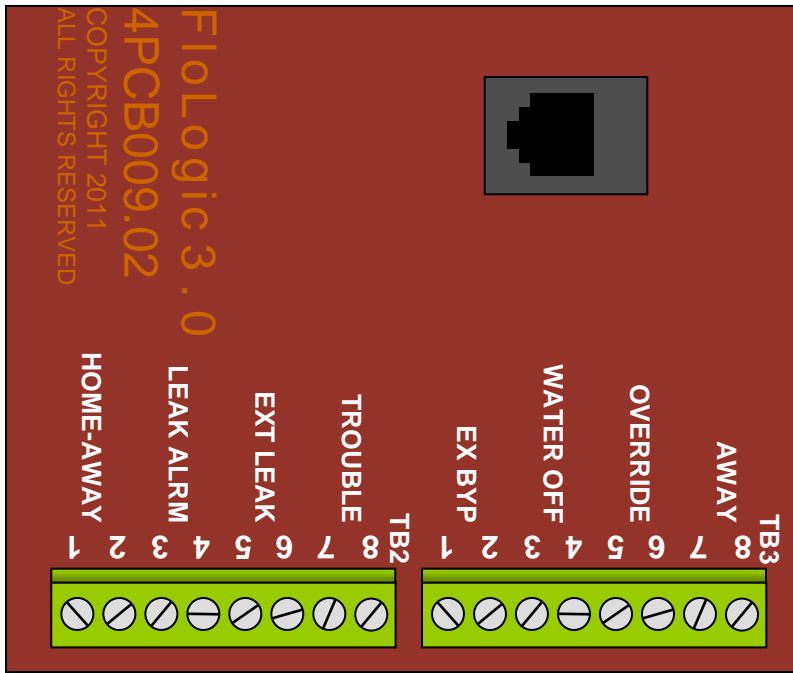

DESCRIPTION	LOCATION	WIRING
HOME-AWAY – Contact closure triggers the System to the AWAY mode.	TB2 Pins 1 & 2	Connect to security system contacts that close (short) when security system is armed to away. Contacts should open when security system is disarmed.
LEAK ALARM – Communicates LEAK event to external system or device.	TB2 Pins 3 & 4	Solid State Relay is Normally Open. Relay will close when a leak event is detected. Relay reverts to open after alarm is cleared at keypad.
EXT LEAK – Momentary contact closure triggers the System to shut the Valve and sound EXT LEAK alarm. Used to connect external moisture sensor or low tem sensor.	TB2 Pins 5 & 6	Connect to external system contacts that momentarily close (short) when water is detected by moisture sensor devices or freezing conditions exist. Once triggered, water service must be restored at the Control Panel.
TROUBLE - Communicates loss of AC power or other system trouble events needing attention. Connect to external alarm or monitoring system.	TB2 Pins 7 & 8	Solid State Relay is Normally Open. Relay will close when a FloLogic System trouble event is detected and open when cleared. AC LOSS reporting is delayed for one hour. All others trouble conditions are immediate.
EXT BYPASS – Momentary contact closure starts the BYPASS timer (Timed Disable of System).	TB3 Pins 1 & 2	Connect to any external device with contacts that momentarily close (short) when the external device begins using water.
WATER OFF – Communicates to external device or system when valve is closed (LEAK, EXT LEAK, or WATEROFF)	TB3 Pins 3 & 4	Solid State Relay is Normally Open. Relay will close when the water is turned off by the FloLogic System for any reason (LEAK, WATEROFF, EXT LEAK). Relay opens when water service is restored.
OVERRIDE – Latching contact closure triggers System to disable flow timer. Timer reactivated when contact opens.	TB3 Pins 5 & 6	Connect to any external device with contacts that latch close (short) when flow detection needs to be disabled. Typical uses include water softeners and irrigation.
AWAY – Communicates to external device or system when FloLogic is in the AWAY mode.	TB3 Pins 7 & 8	Solid State Relay is Normally Open. Relay will trigger closed when the FloLogic System is placed in the AWAY mode and revert to open when in the HOME mode.

WIRING OUTPUTS TO EXTERNAL SYSTEMS

Using Onboard Solid State Relay (SSR) Outputs

WIRING NOTES:

The onboard SSR outputs can power DC relays of 3V to 48V, and AC relays of 3V to 24V. 48VAC is not supported. Maximum load current through the SSR is 110mA at 50C (120F). Onboard relay has 14 ohm resistance on closure, 22 ohm max.

If switched voltage or the required load current exceeds the specified limits above, an external relay will be required.

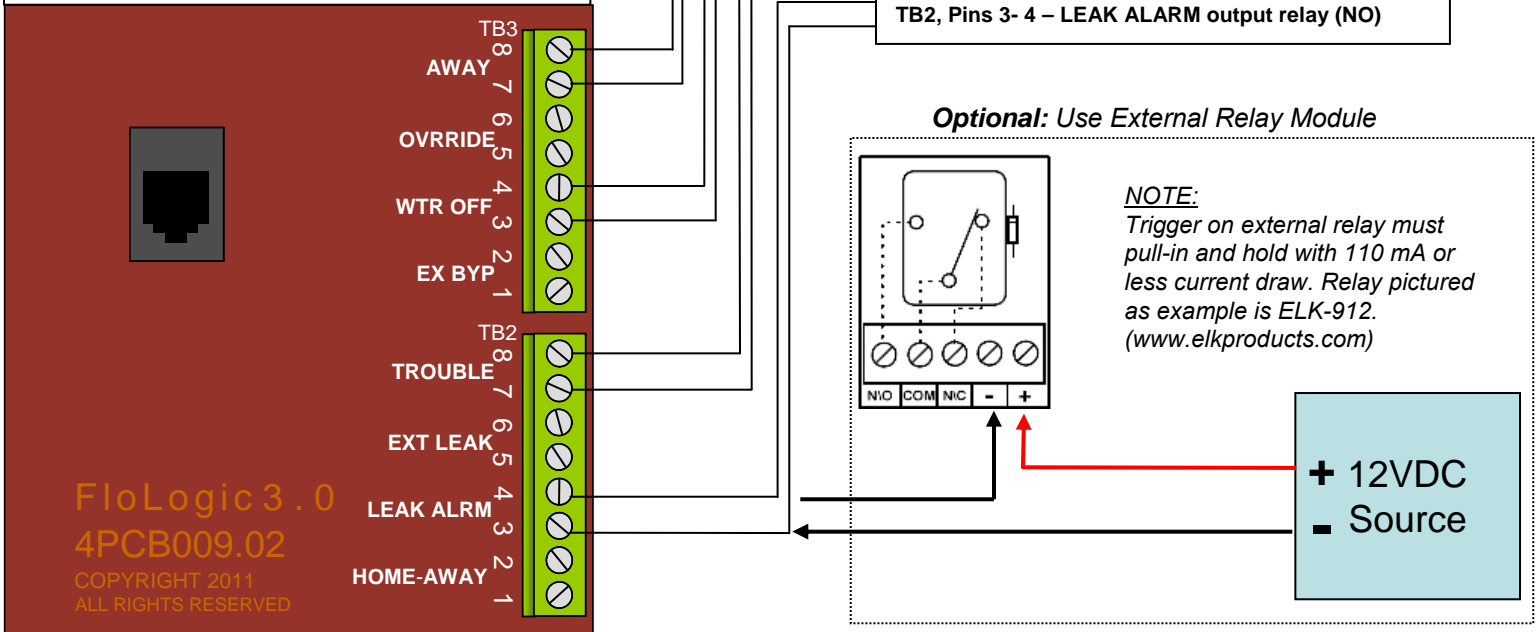

<u>Output</u>	<u>Trigger Event</u>	<u>Location</u>	<u>Normally</u>	<u>Action on Event</u>
LEAK ALRM	Valve closed due to leak	TB2 Pins 3 / 4	Open	Relay closes
TROUBLE	System fault	TB2 Pins 7 / 8	Open	Relay closes
WTR OFF	Valve closed for any reason	TB3 Pins 3 / 4	Open	Relay closes
AWAY	System in AWAY mode	TB3 Pins 7 / 8	Open	Relay closes

Application Notes:

- AC Lost trouble output is delayed for one hour to prevent cycling of alarm during brief power outages
- Water Off output is useful for shut-down of hot water recirculation pumps or well pumps
- Away Mode output can be directly connected to second FloLogic HOME-AWAY input

IRRIGATION OVERRIDE

If Sprinkler Feed is Tapped After FloLogic Valve

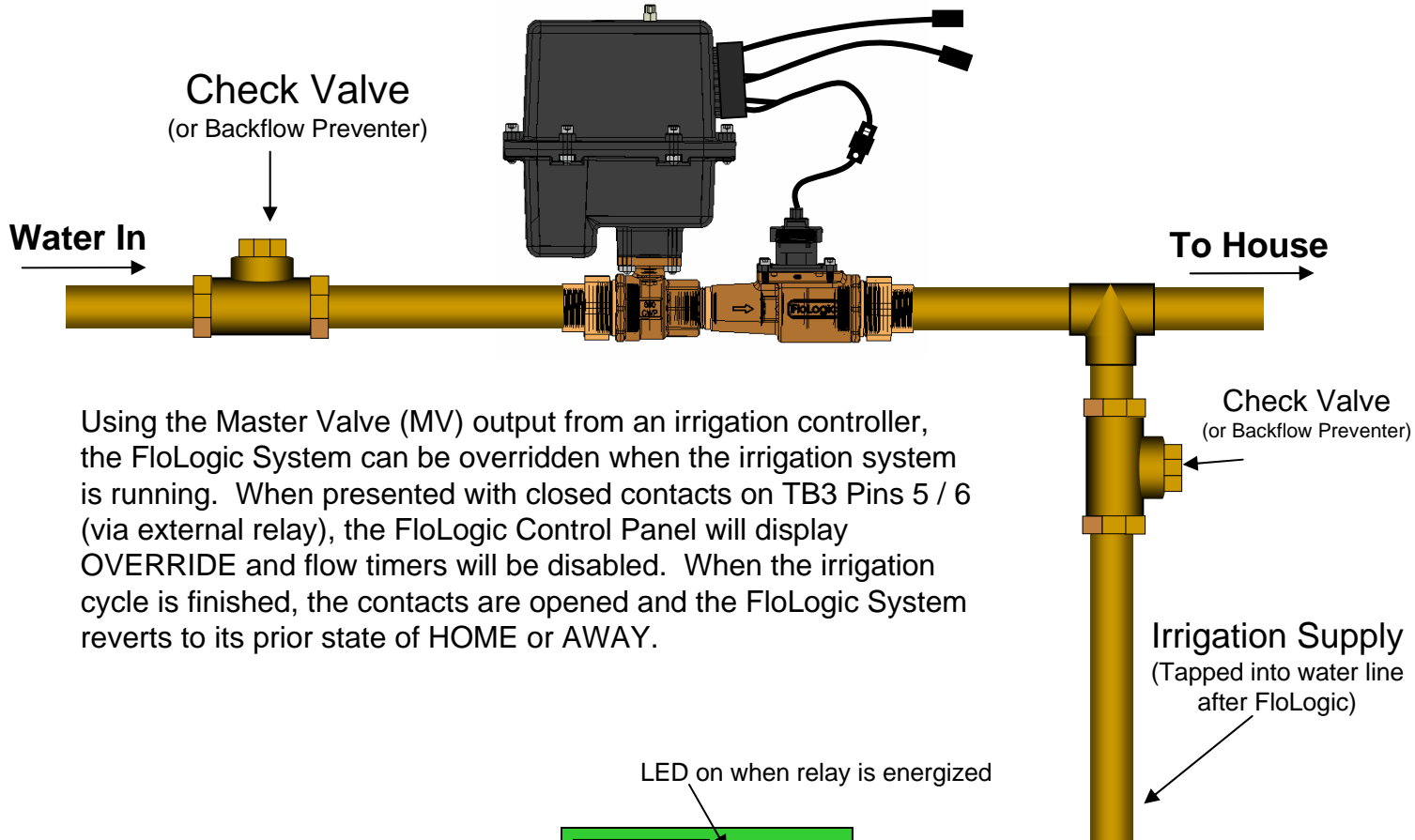

Using the Master Valve (MV) output from an irrigation controller, the FloLogic System can be overridden when the irrigation system is running. When presented with closed contacts on TB3 Pins 5 / 6 (via external relay), the FloLogic Control Panel will display **OVERRIDE** and flow timers will be disabled. When the irrigation cycle is finished, the contacts are opened and the FloLogic System reverts to its prior state of HOME or AWAY.

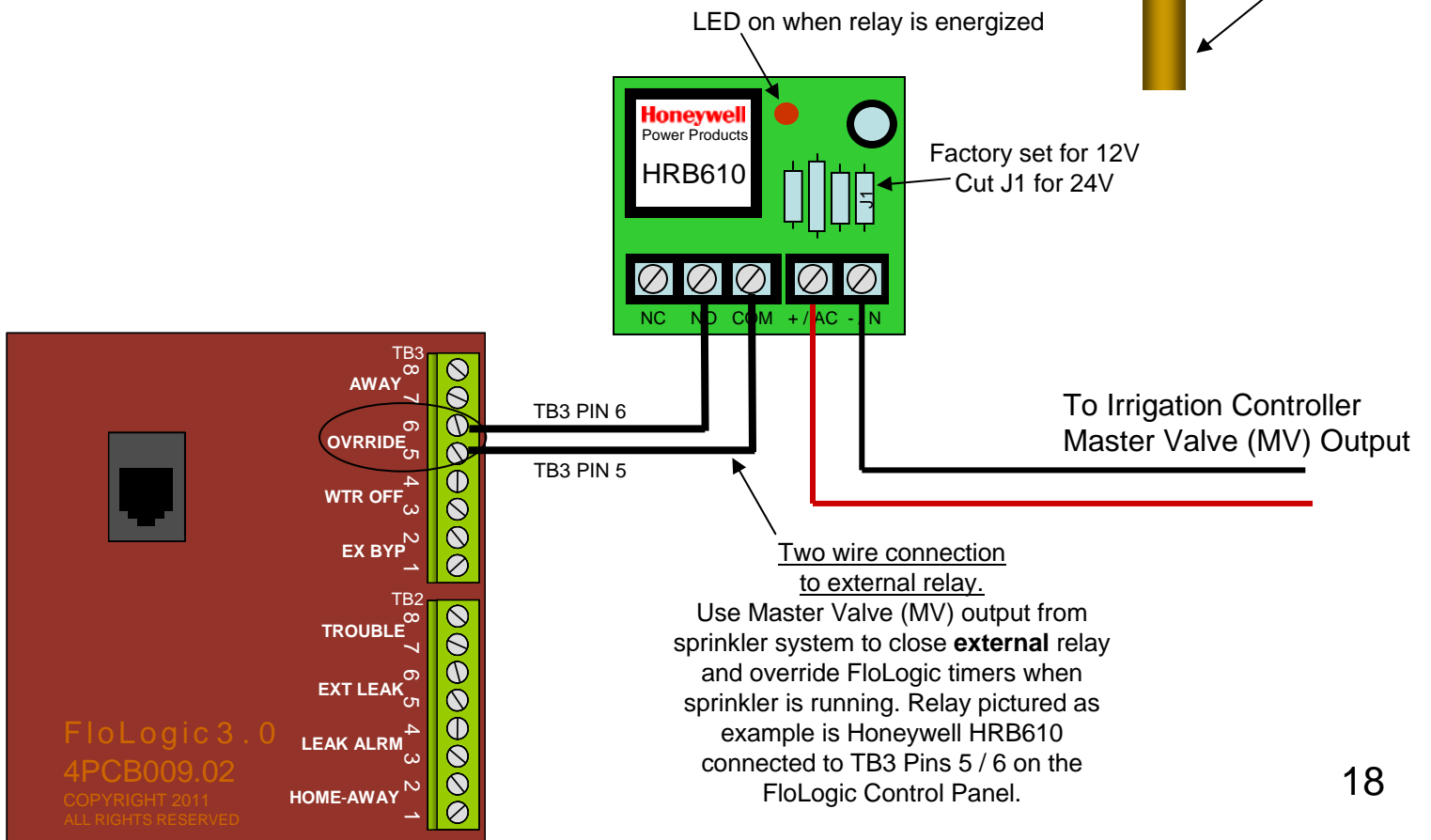

WATER SOFTENER - REGEN CYCLE OVERRIDE

When Softener is Installed AFTER the FloLogic System
 Use Flow Switch to Trigger EXT BYPASS or OVERRIDE
 (NOTE: Can Be Used for Any Low-Flow (1/2" or less) System Requiring Backwash)

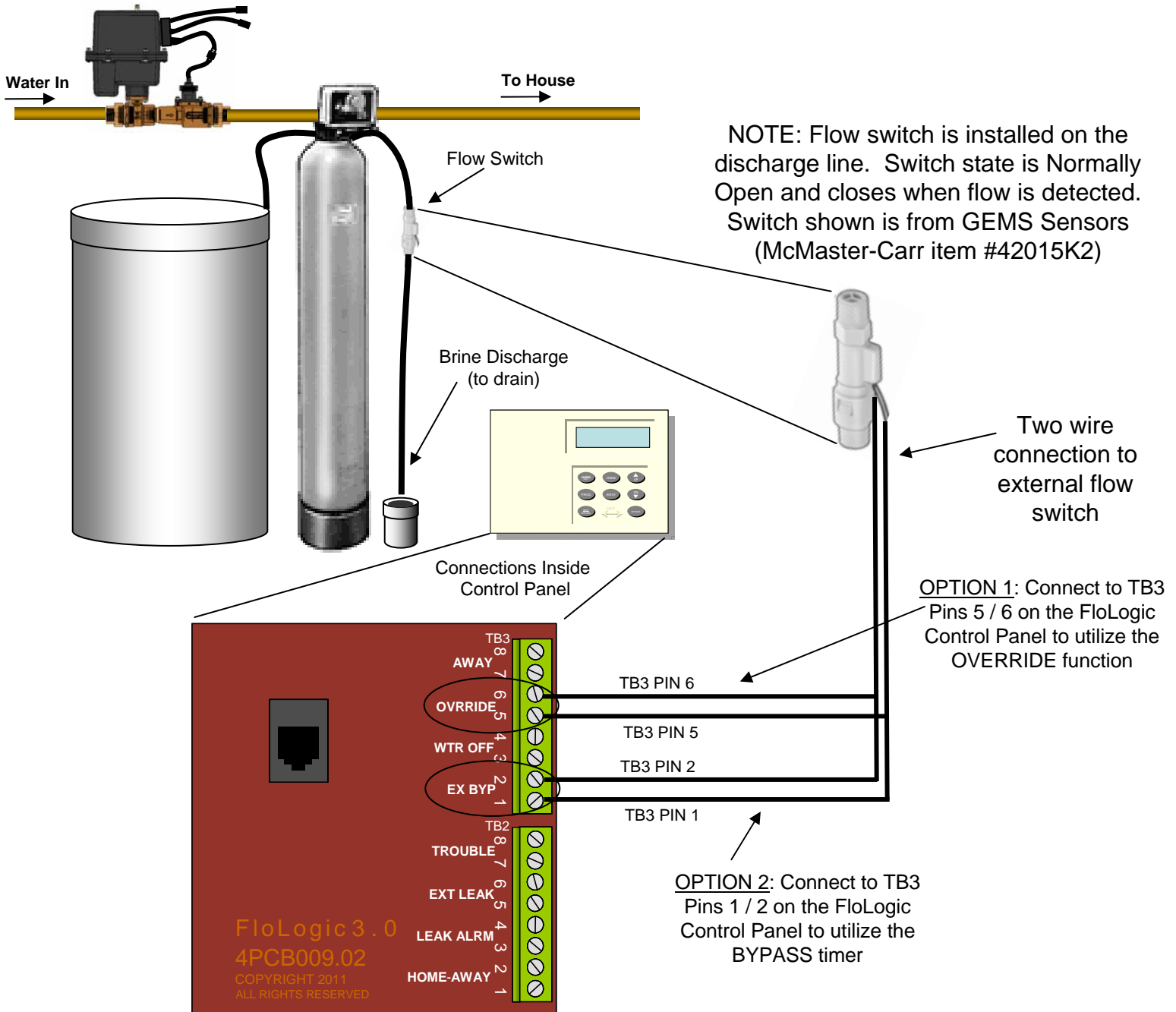

OPTION 1 NOTE: If connected to OVRRIIDE, the flow timers will be overridden when any flow is detected in the discharge line and the display will read OVERRIDE alternating with HOME or AWAY. When flow stops, the System will revert to the mode it was in prior to the OVERRIDE event, HOME or AWAY.

OPTION 2 NOTE: If connected to EX BYP, the bypass interval timer will be started when flow is detected in the discharge tube and the display will read EX.BYPASS alternating with HOME or AWAY. The bypass interval should be set to a value that is equal to or greater than the time required for the regeneration cycle of the softener. Typically this will be around 90-100 minutes. The System is shipped with a default setting of 120 minutes for the bypass interval. When the bypass interval expires, the System will revert to HOME or AWAY.

HOSE BIB / POOL FILL - OVERRIDE WITH FLOW SWITCH

If Water Feed is Tapped Downstream of FloLogic Valve
Can be Used for Any Higher-Flow (3/4") Applications

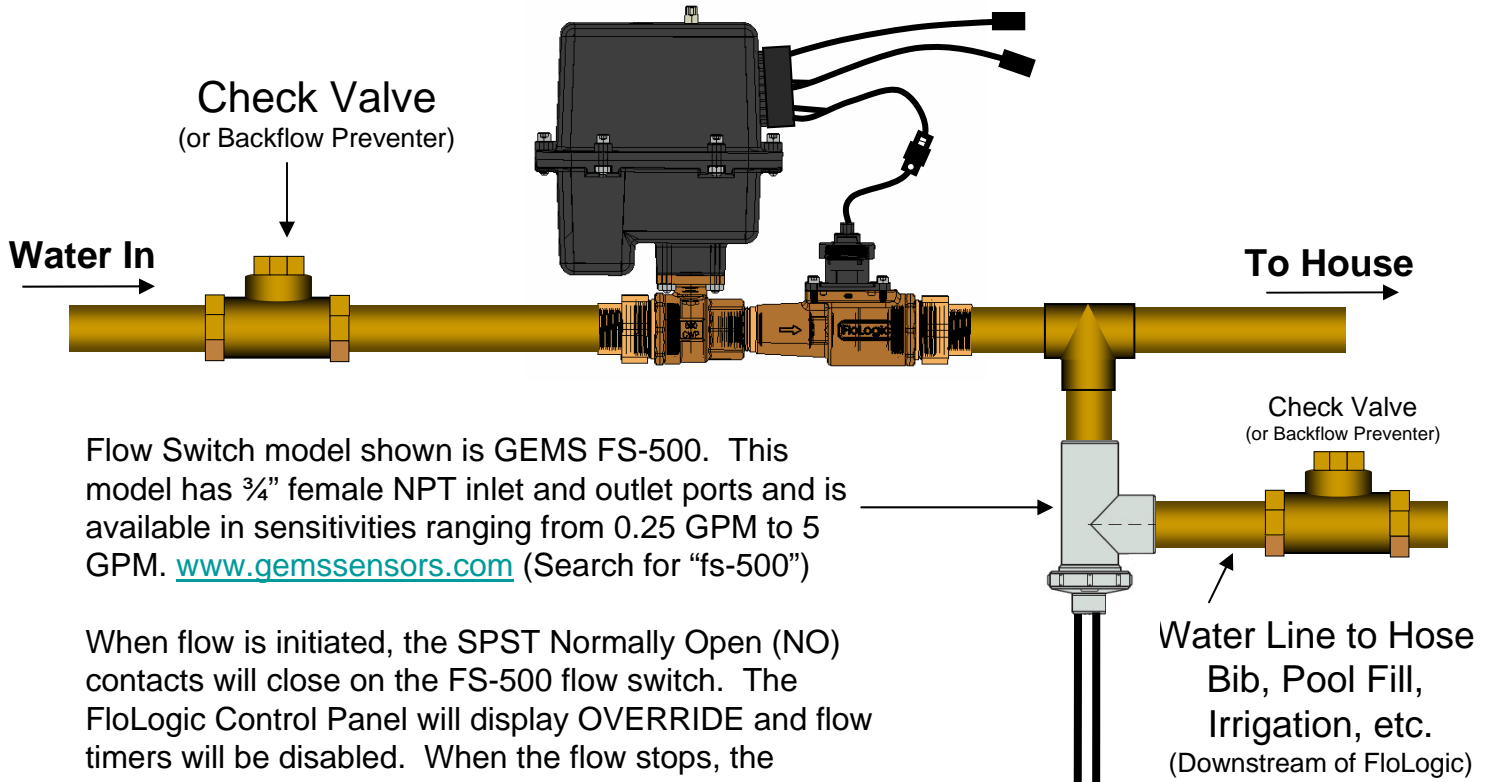

Flow Switch model shown is GEMS FS-500. This model has 3/4" female NPT inlet and outlet ports and is available in sensitivities ranging from 0.25 GPM to 5 GPM. www.gemssensors.com (Search for "fs-500")

When flow is initiated, the SPST Normally Open (NO) contacts will close on the FS-500 flow switch. The FloLogic Control Panel will display **VERRIDE** and flow timers will be disabled. When the flow stops, the contacts are opened and the FloLogic System reverts to its prior state of **HOME** or **AWAY**.

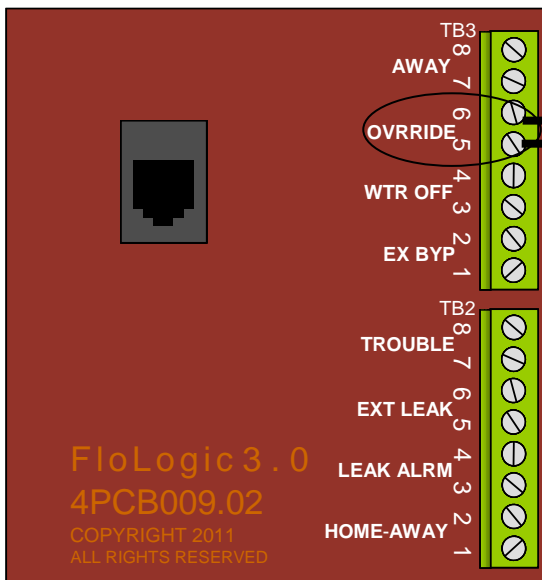

TB3 PIN 6

TB3 PIN 5

Two wire connection to flow switch.

FloLogic 3.0
4PCB009.02
COPYRIGHT 2011
ALL RIGHTS RESERVED

CONTROLLING A 120 VAC CIRCUIT

External Form C Relay Switches AC

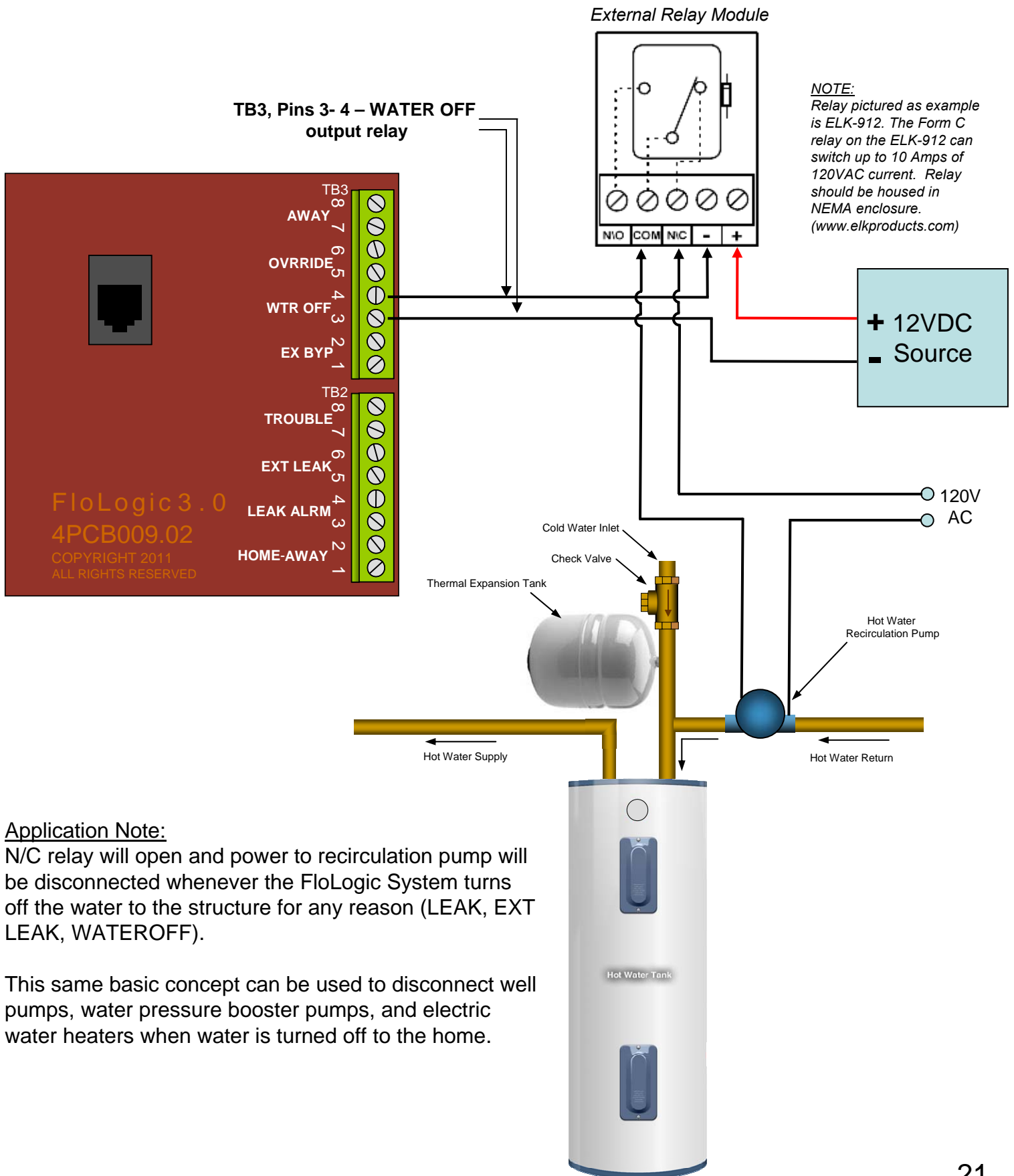

Application Note:

N/C relay will open and power to recirculation pump will be disconnected whenever the FloLogic System turns off the water to the structure for any reason (LEAK, EXT LEAK, WATEROFF).

This same basic concept can be used to disconnect well pumps, water pressure booster pumps, and electric water heaters when water is turned off to the home.

WATERTIGHT CONNECTER MANIPULATION

IMPORTANT NOTE: Only pull the plastic connector body when un-mating.
Do not pull the wires.

Connector mated but not locked.

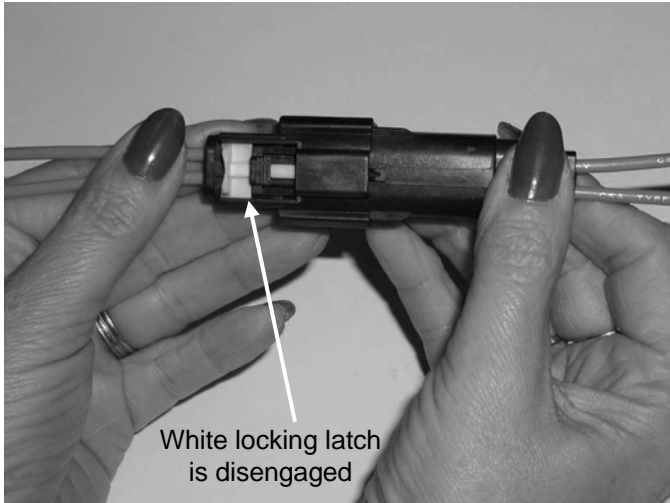

Depress the black tab and pull to un-mate the connector. NOTE: It may be difficult to press.



Push the white locking latch forward to double lock the connector



Locking latch shown all the way forward. The connector is double locked and mated properly.



You know the connector is mated properly because when it is unmated you cannot push the locking latch forward.



NOTE: To make the mating and un-mating task easier, you can remove and discard the white locking latch by grasping the end of the latch with a pair of needle nose pliers and pulling it out. The locking latch is not required for proper operation of the connector except in high vibration applications.

STANDARD PRODUCT WARRANTY

(Extended Warranties Available for Purchase)

FloLogic® System 3.0 Warranty (for Customers in the United States)

In consideration for your purchase of the FloLogic System 3.0,

Keep your receipt.
Proof of the original purchase date is needed to obtain service under the warranty

For The Period Of: We Will Replace:

One Year
From the date of the original purchase
*Any part of the FloLogic System which fails due to a defect in materials or workmanship. During this **limited one-year warranty**, FloLogic will repair or replace, **free of charge**, any defective part of the System 3.0. You will be responsible for any in-home service and return shipping of the defective part to FloLogic.*

Five Years
From the date of the original purchase
*The **primary flow path including the valve and low-flow diverter**, if either fails due to a defect in materials or workmanship. During this **five year limited warranty**, you will be responsible for any in-home service and return shipping charges.*

What Is Not Covered

- Service trips to your home to teach you how to use the product.
- Improper installation, delivery, or maintenance.
- Failure of the product if it is abused, misused, or used for other than the intended purpose.
- Defects that result from improper installation or damage not caused by FloLogic.
- Liability on the part of FloLogic under this or any other warranty for any indirect or consequential damage.
- Defective operation of the System due to user programming errors.
- Damage or operational deficiencies due to water quality issues such as sediment or scale accumulation.
- Replacement of house fuses or resetting of circuit breakers.
- Battery replacements.
- Damage to the product caused by accident, fire, floods, or acts of God.
- Incidental or consequential damage caused by possible defects with this product, its installation, or repair.
- Damage caused after delivery.

This warranty is extended to the original purchaser and is transferable to any succeeding owner for products purchased for use within the USA. In Alaska and Hawaii, the warranty excludes the cost of shipping repair or replacement parts to your home or business. This warranty is void if the actuator cover is removed or the flow sensor is disassembled.

Some states do not allow the exclusion or limitation of incidental or consequential damages. This warranty gives you specific legal rights, and you may have other rights which vary from state to state. To know what your legal rights are, consult your local or state consumer affairs office or your state's Attorney General.
THIS WARRANTY IS INTENDED TO BE IN LIEU OF OTHER WARRANTIES, WHETHER EXPRESS OR IMPLIED, INCLUDING THE WARRANTIES OF MERCHANTABILITY AND FITNESS FOR A PARTICULAR PURPOSE.

BASIC SYSTEM LAYOUT

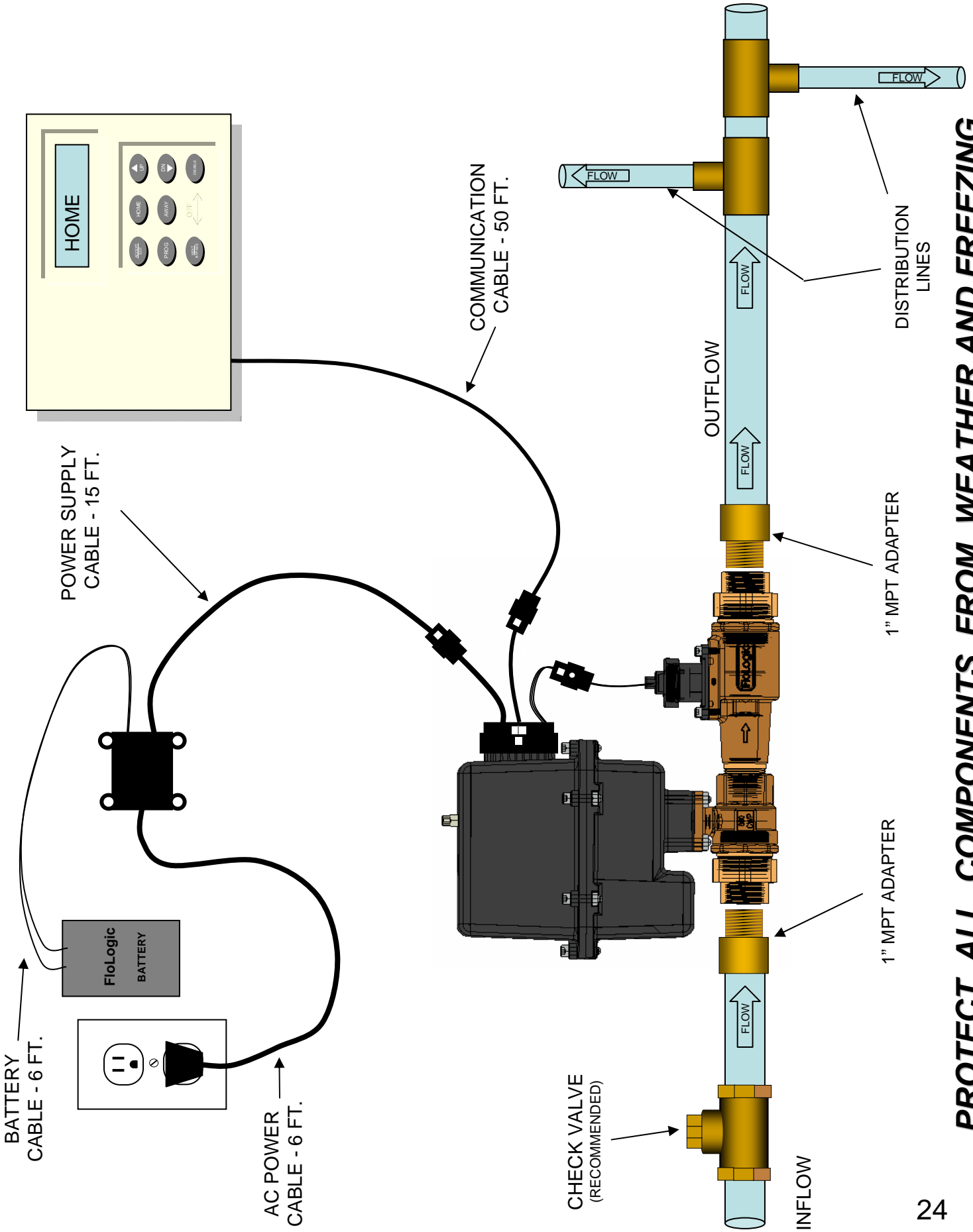

PROTECT ALL COMPONENTS FROM WEATHER AND FREEZING